

A ( 1 : 4 )

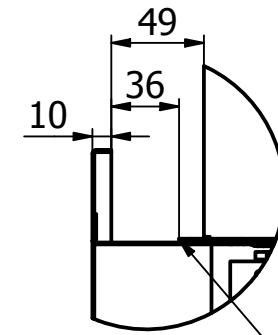

Zakończenie ramki drzwiczek.

B ( 1 : 4 )

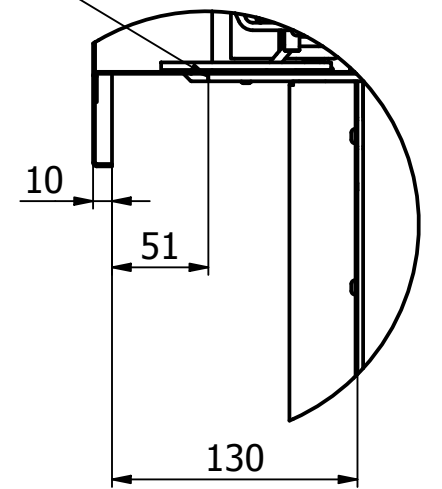

Zakończenie ramki drzwiczek.

C ( 1 : 4 )

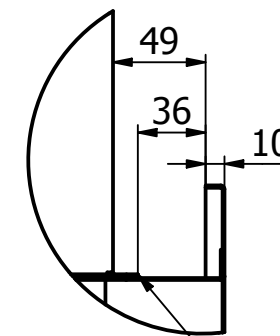

Zakończenie ramki drzwiczek.

D ( 1 : 4 )

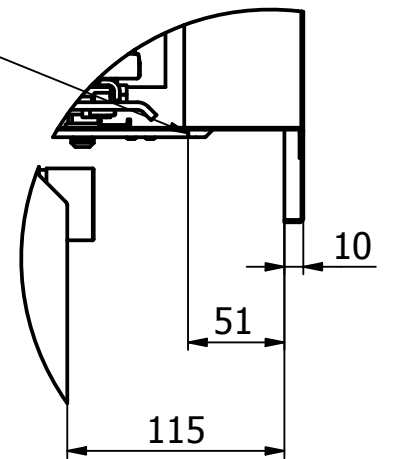

Zakończenie ramki drzwiczek.

E ( 1 : 4 )

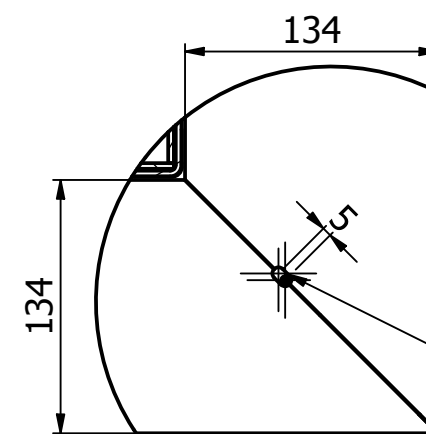

Możliwość regulacji.

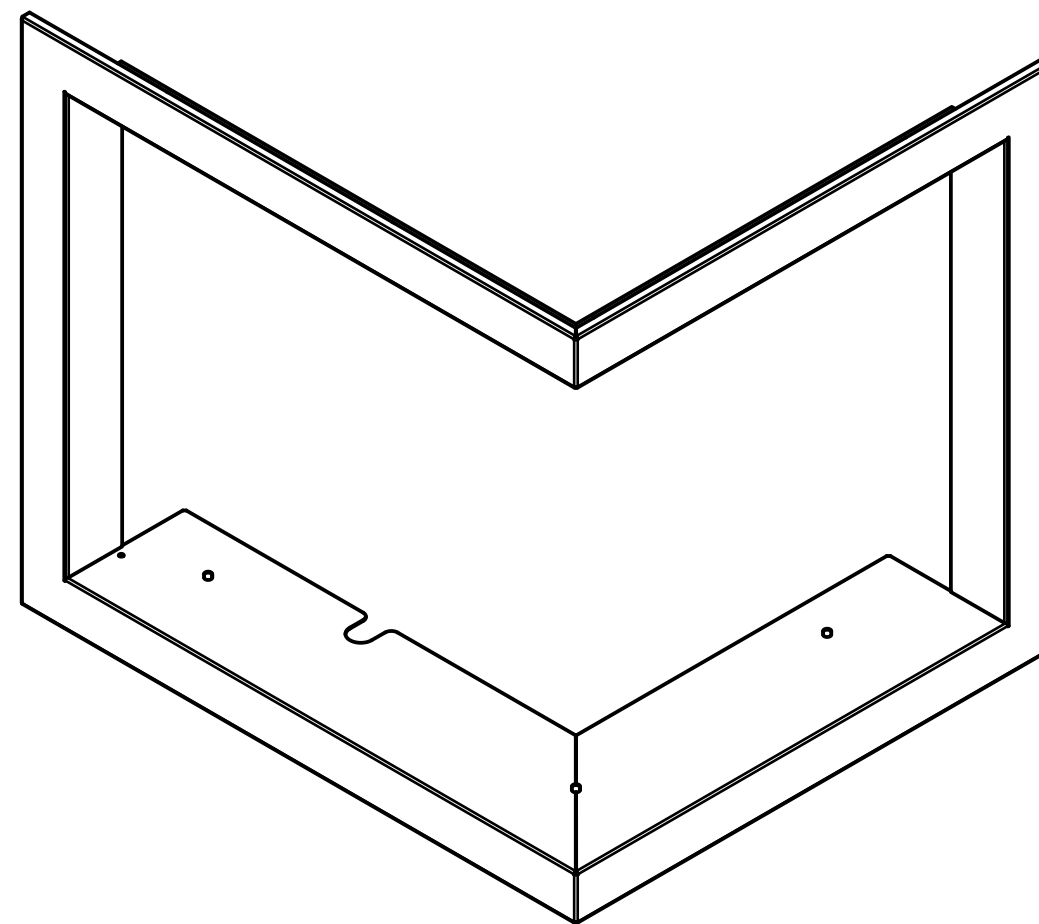
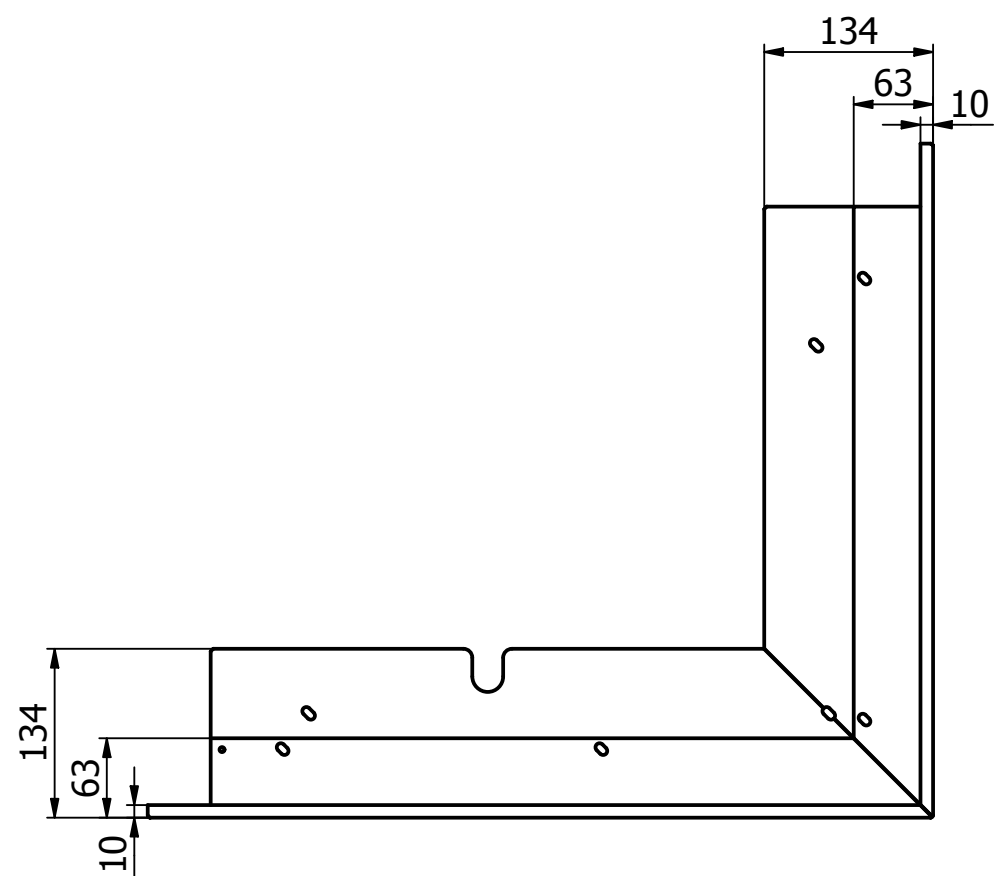
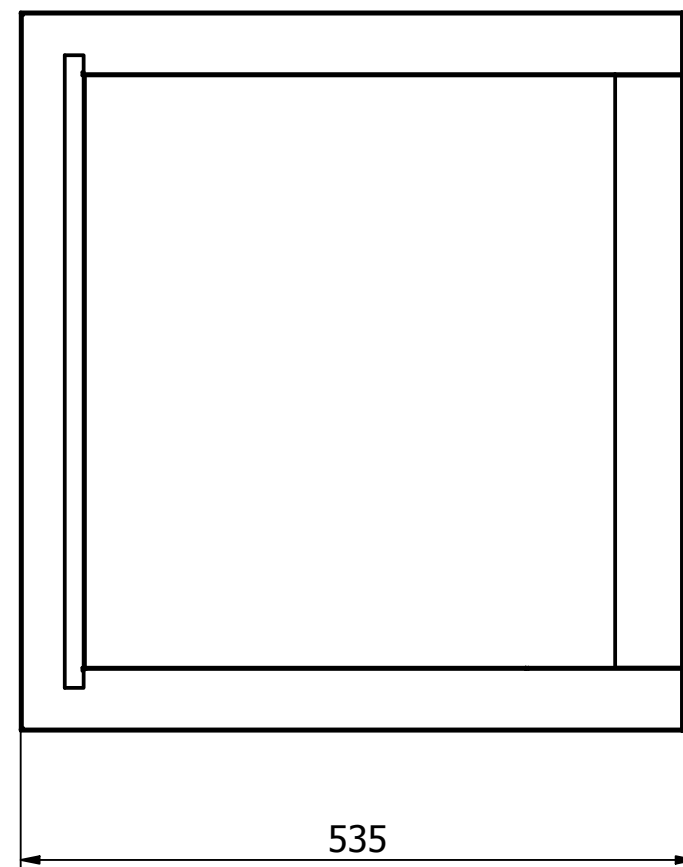
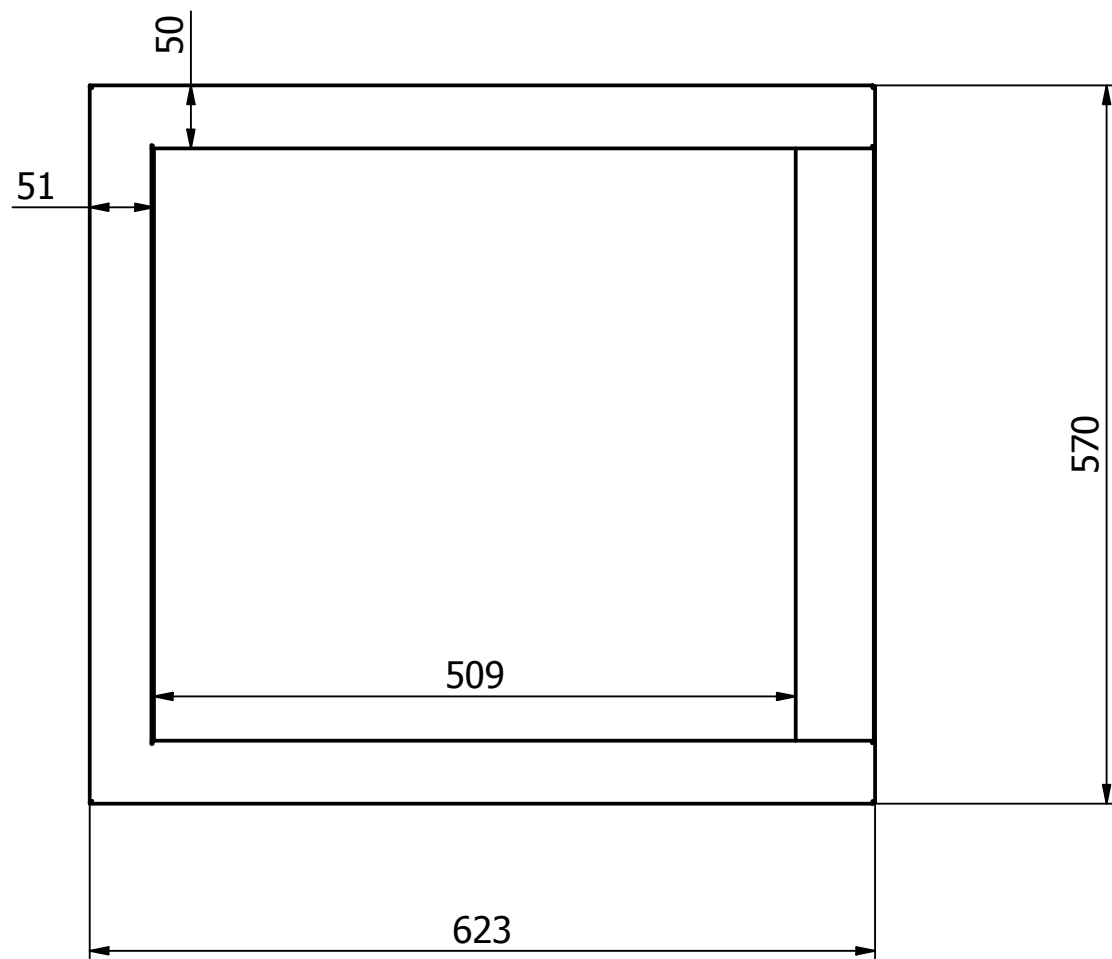

Maskownica 50 płytka