

A (1:4)

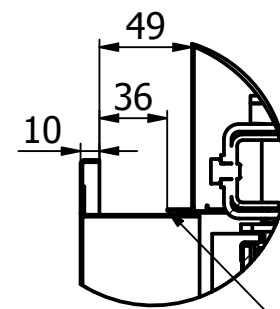

B (1:4)

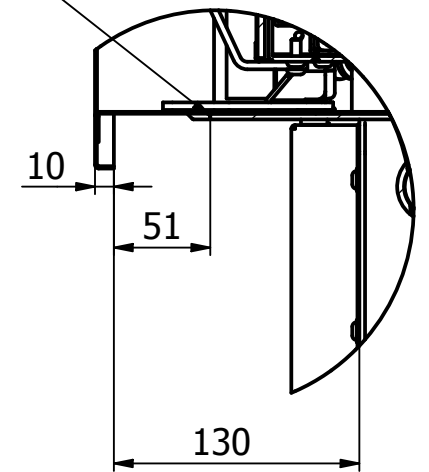

Zakończenie ramki drzwiczek.

Zakończenie ramki drzwiczek.

C (1:4)

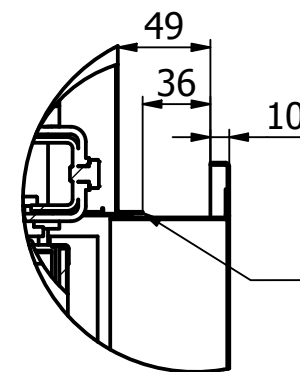

D (1:4)

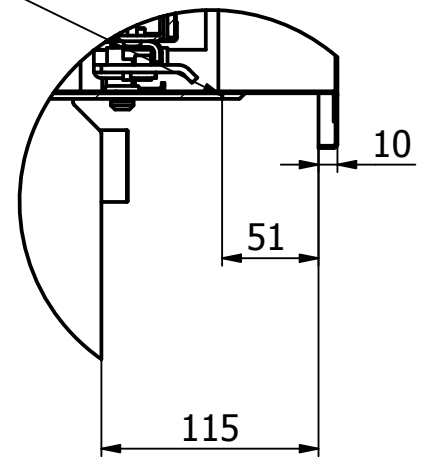

Zakończenie ramki drzwiczek.

Zakończenie ramki drzwiczek.

E (1:5)

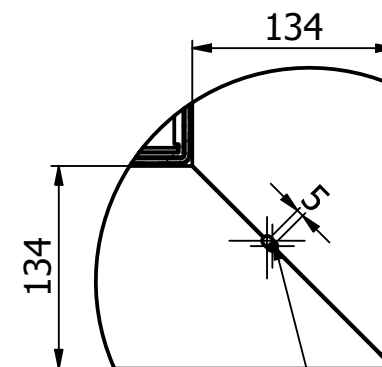

Możliwość regulacji.

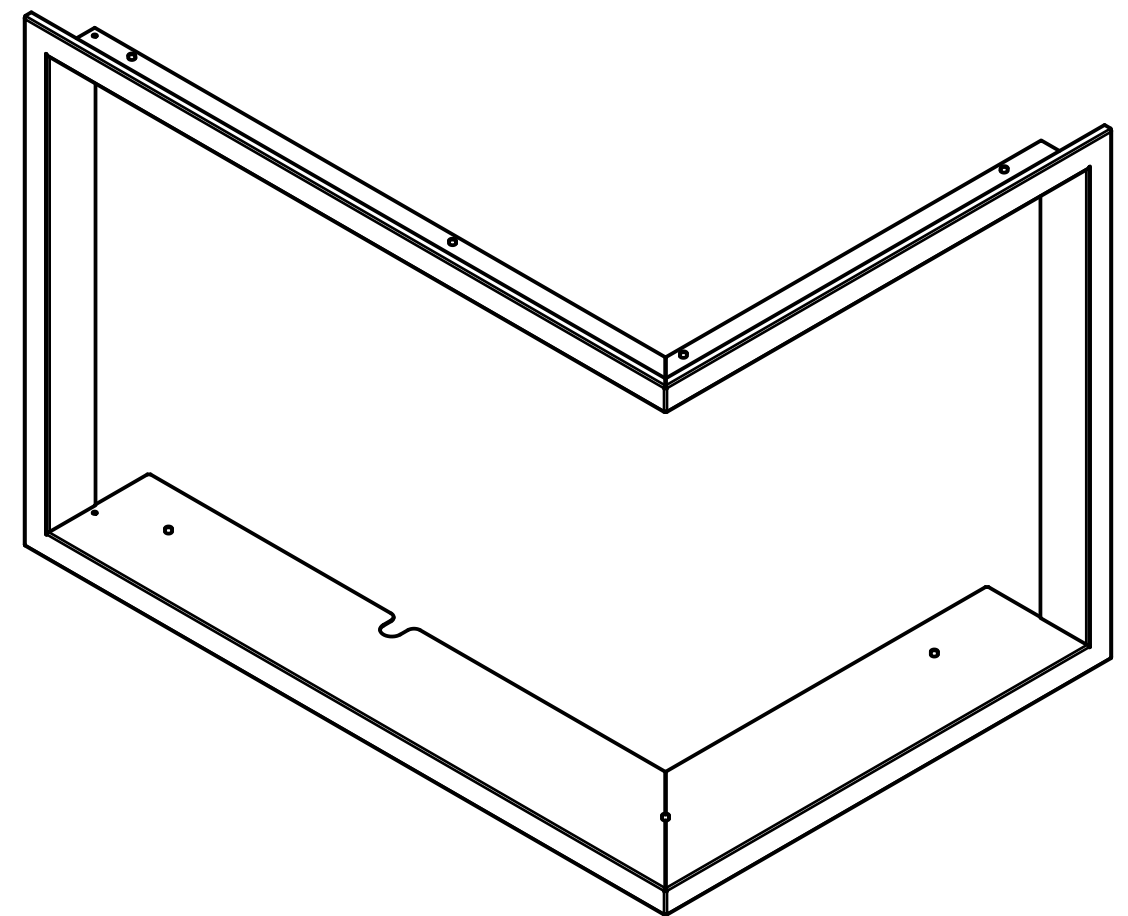
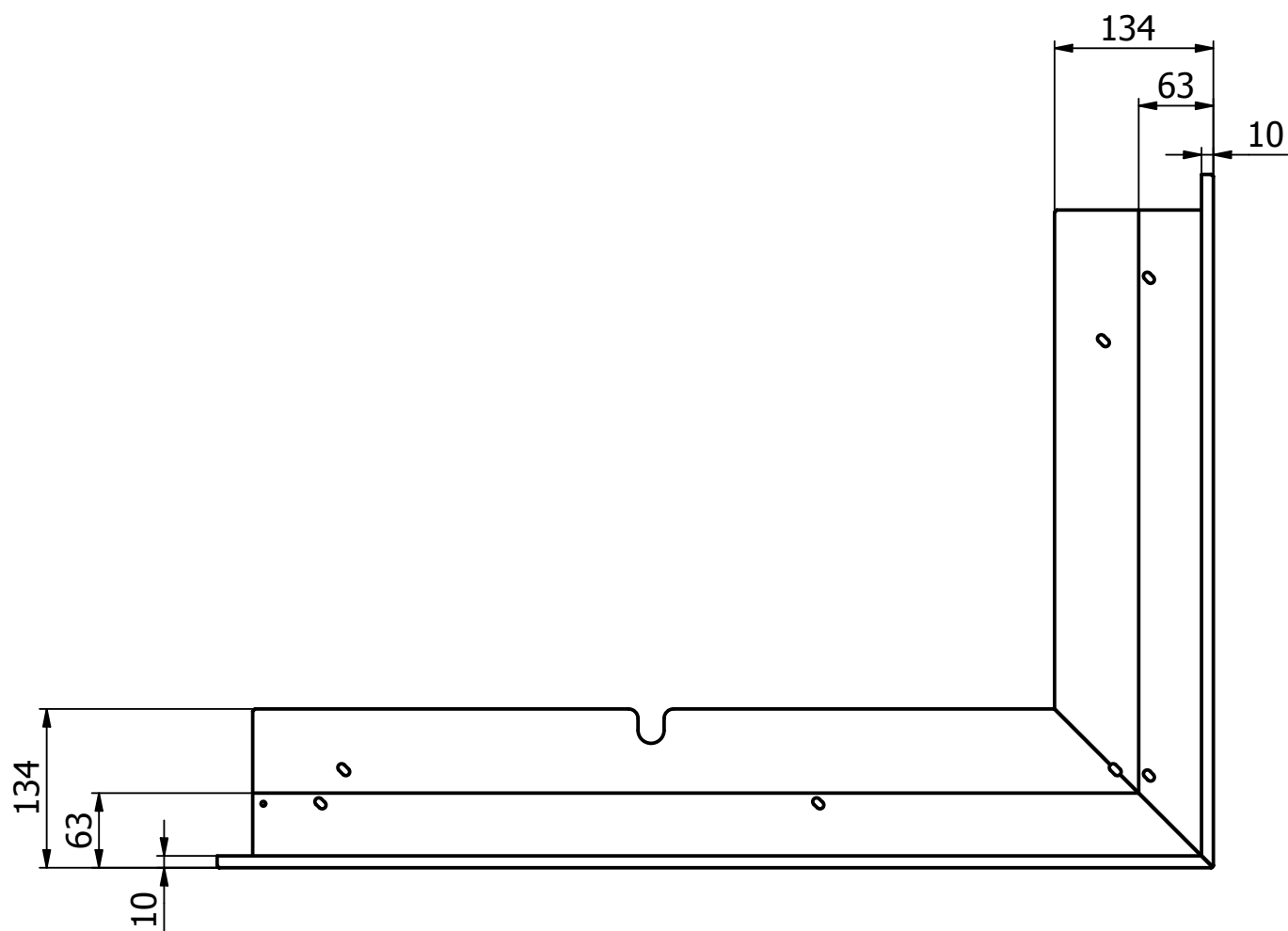
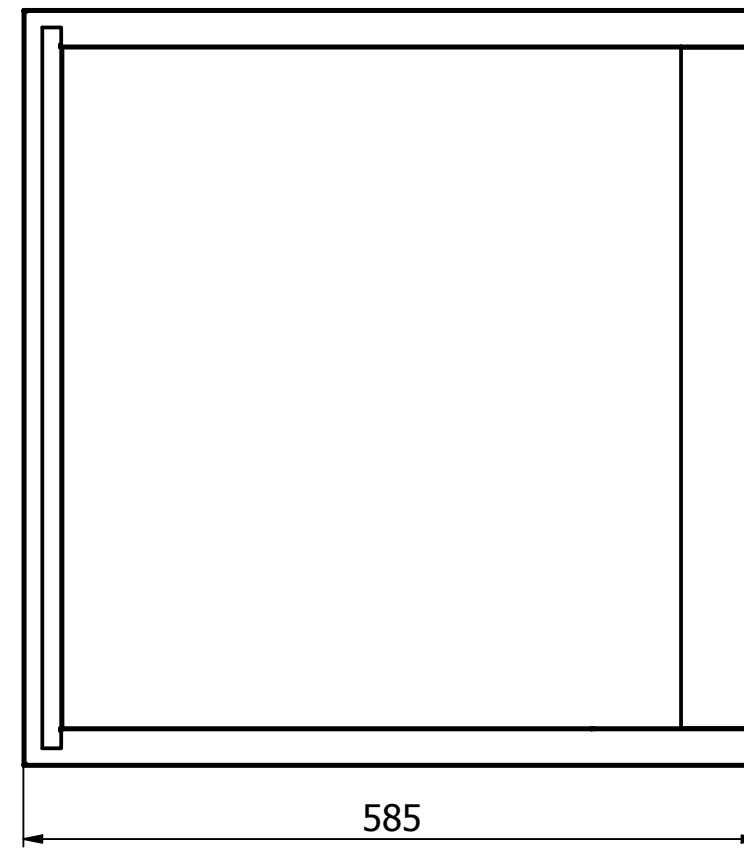
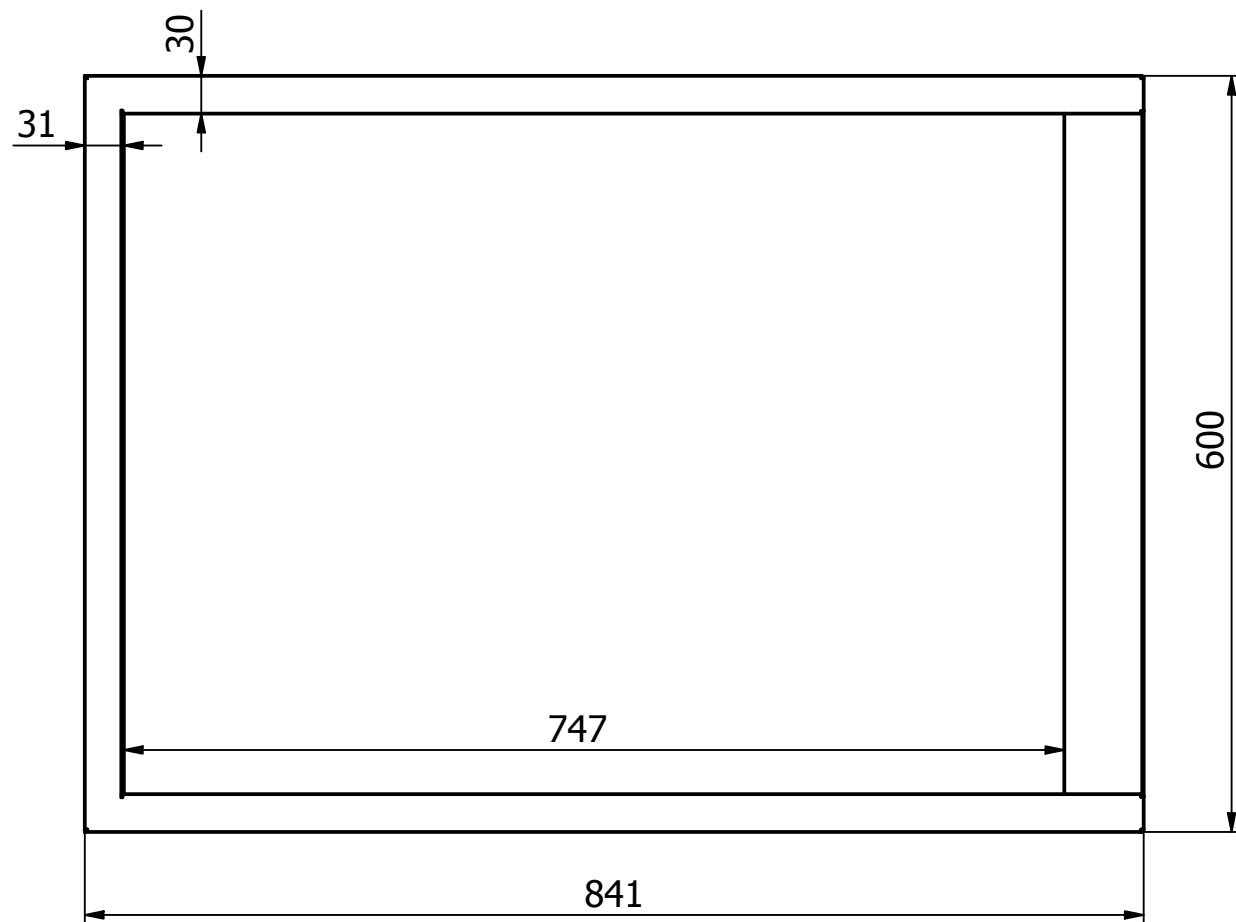

Maskownica 30 płytka